

Buttweld Fittings

A pipe fitting is defined as a part used in a piping system, to change direction or function, which is mechanically joined to the system.

Probably the simplest way to achieve this would be to bend the pipe in the direction required, but this process will stretch and thin the outer wall whilst thickening and wrinkling the inner wall. This results in flow resistance and accelerated wall erosion.

A second method sometimes used is a mitre joint, where pipes are cut to the correct angle and welded together to achieve the desired change. Whilst the cross-sectional area and wall thickness are maintained, a great deal of efficiency is lost due to friction and turbulence resulting from the severe changes in direction. For example, a single-mitre bend offers about six times the resistance of a swept elbow.

For these reasons swept fittings are preferred on most piping systems, particularly where internal pressure, flow and corrosion are of major consideration.

TYPES AND APPLICATIONS OF BUTTWELD FITTINGS

A piping system using buttweld fittings has many inherent advantages over other forms.

- Welding a fitting to the pipe means it is permanently leakproof.
- The continuous metal structure formed between pipe and fitting adds strength to the system.
- Smooth inner surface and gradual directional changes reduce pressure losses and turbulence and minimise the action of corrosion and erosion.
- A welded system utilises a minimum of space.

90° ELBOWS

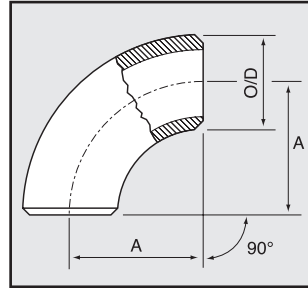

The function of a 90° elbow is to change direction or flow in a piping system. Elbows are split into three groups which define the distance over which they change direction, expressed as a function of the distance from the centre line of one end to the opposite face. This is known as the centre to face distance and is equivalent to the radius through which the elbow is bent.

Long Radius Elbow

The most common is the long radius (LR) elbow where the centre to face dimension is always 1-1/2 times the nominal pipe size of the elbow.

Short Radius Elbow

In this case the centre to face dimension is the same as the nominal pipe size of the elbow.

Extra Long Radius

This is where the centre to face dimension is longer than the standard long radius type. The most common of these is where the centre to face dimension is three times the nominal size. i.e. 3D.

45° ELBOWS

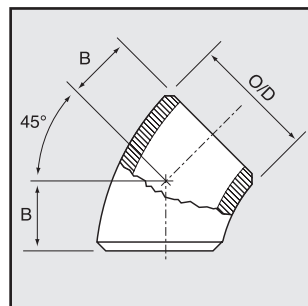

The function of a 45° elbow is the same as a 90° elbow, but the measurement of dimensions, however, is different to that of the 90° elbow. The radius of a 45° elbow is the same as the radius of the 90° LR elbow where 'R' equals 1-1/2 x D. However, the centre to face dimension is not equivalent to the radius as in 90° LR elbows. This is measured from each face to the point of intersection of the centre lines perpendicular to each other. This is due to the smaller degree of bend.

180° RETURN BENDS

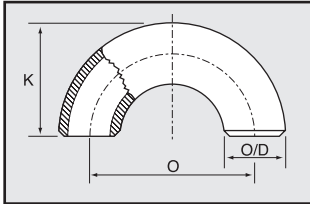

The function of a 180° return bend is to change direction of flow through 180° and there are two basic types, long radius and short radius. Both types have a centre to centre dimension double the matching 90° elbows. The primary application for these fittings is in heater coils and heat exchangers, boilers etc.

ECCENTRIC AND CONCENTRIC REDUCERS

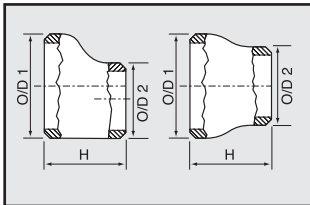

The function of both types of reducer is to reduce the line from a larger to a smaller pipe size, this obviously results in an increased flow pressure. With the eccentric reducer the smaller outlet end is off centre to the larger end enabling it to line up with one side of the inlet and not with the other.

The concentric reducer is so manufactured that both inlet and outlet ends are on a common centre line. The concentric reducer is easier and less expensive to produce but does not allow quite the same versatility as the eccentric reducer. The lengths of both types are fixed by manufacturing standards.

EQUAL AND REDUCING TEES

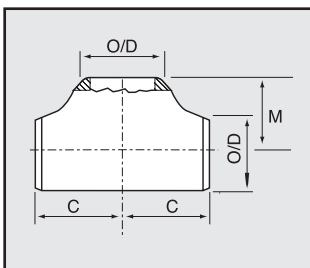

The function of a tee is to permit flow at 90° to the main direction of flow. The main flow passes through the 'run' whilst the 90° outlet is known as the 'branch'. The equal tee is manufactured with all three outlets being the same size.

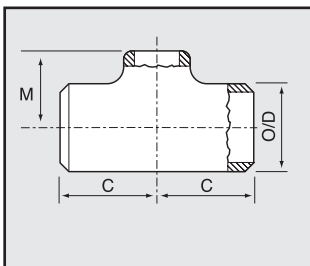

The reducing tee is manufactured with the branch outlet smaller than the run to obtain the desired flow and pressure through the system.

EQUAL AND REDUCING CROSSES

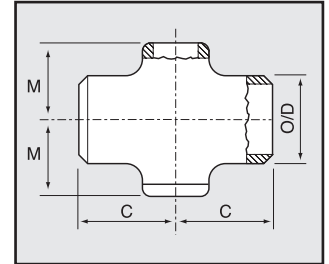
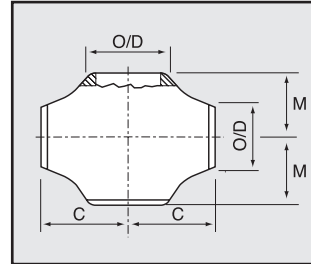

The function of a cross is similar to that of a tee with the exception of providing two 90° outlets opposite each other. Equal crosses have all four outlets of equal size. Reducing crosses have branches that are smaller in size to that of the run to obtain the desired flow and pressure through the system.

CAPS

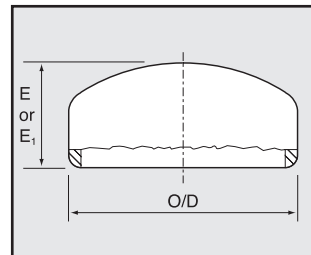

The function of an end cap is to block off the end of a line in piping systems. This is achieved by placing the end cap over the open line and welding around the joint.

STUB ENDS

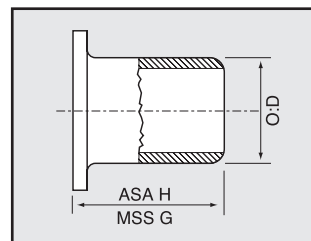

A stub end and its associated slip-on flange allows quick disconnection of the particular section involved as well as easy alignment of mating flanges. Stub ends are installed in pairs and mated together with two slip-on

flanges. The surface of the stub end has a phonographic serrated gasket surface which prevents leakage at the joint.

There are two basic types of stub end, ANSI types A & B long barrel, and M.S.S. types short barrel. Under certain design criteria such as temperature or pressure, it is not acceptable to have the joint between stub end and pipe in close proximity with the flange joint, in these applications ANSI types are used.

Type A stub ends are used with lap joint flanges.

Type B stub ends are used with slip-on flanges.

BUTTWELD FITTINGS WEIGHTS & DIMENSIONS

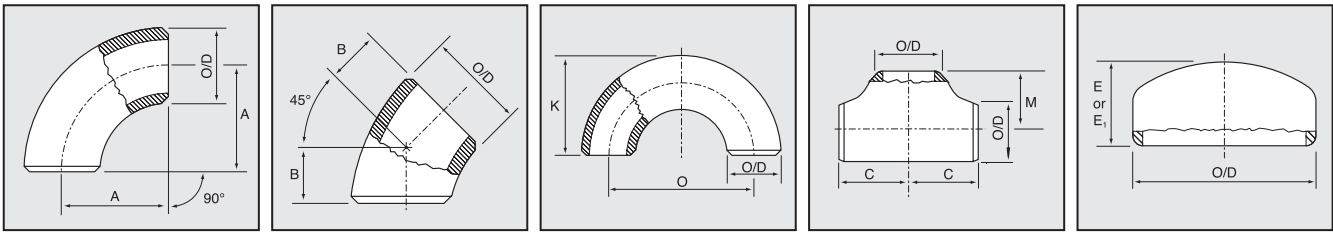

Nominal Size		WT SCH	90° LR ELBOW		45° LR ELBOW		90° SR ELBOW		180° LR ELBOW			Equal Tee		Caps			
mm	inch		A	Weight	B	Weight	A	Weight	O	K	Weight	C and M	Weight	E†	Limiting Wall	E‡	Weight
15	1/2	5S	38	0.05	16	0.03	-	-	76	48	0.11	25	0.09	25	4.57	25	0.04
		10S		0.06		0.03					0.12		0.10				
		40S		0.08		0.04					0.15		0.10				
		80S		0.10		0.05					0.19		0.14				
		160		0.13		0.07					0.24		0.17				
		XXS		0.21		0.11					0.34		0.27				
20*	3/4*	5S	38	0.06	19	0.03	-	-	76	51	0.14	29	0.10	25	3.81	25	0.05
		10S		0.07		0.03					0.18		0.13				
		40S		0.09		0.04					0.20		0.17				
		80S		0.11		0.05					0.22		0.20				
		160		0.16		0.07					0.30		0.29				
		XXS		0.23		0.11					0.40		0.41				
25	1	5S	38	0.09	22	0.05	0.08	-	76	56	0.22	38	0.18	38	4.57	38	0.08
		10S		0.14		0.09					0.27		0.29				
		40S		0.16		0.11					0.30		0.30				
		80S		0.22		0.14					0.42		0.39				
		160		0.30		0.20					0.60		0.54				
		XXS		0.44		0.28					0.78		0.77				
32	1-1/4	5S	48	0.14	25	0.09	0.14	-	95	70	0.34	48	0.34	38	4.83	38	0.09
		10S		0.23		0.11					0.45		0.50				
		40S		0.25		0.17					0.60		0.60				
		80S		0.40		0.23					0.70		0.68				
		160		0.52		0.39					0.90		0.90				
		XXS		0.80		0.45					1.28		1.36				
40	1-1/2	5S	57	0.17	29	0.11	0.20	-	114	83	0.48	57	0.43	38	5.08	38	0.10
		10S		0.31		0.17					0.60		0.68				
		40S		0.40		0.23					0.81		0.86				
		80S		0.51		0.29					1.02		1.02				
		160		0.72		0.40					1.40		1.43				
		XXS		1.03		0.57					1.80		2.05				
50	2	5S	76	0.29	35	0.14	0.29	-	152	106	0.80	64	0.55	38	5.59	44	0.16
		10S		0.51		0.25					1.05		0.85				
		40S		0.71		0.40					1.32		1.29				
		80S		0.91		0.51					1.92		1.59				
		160		1.43		0.80					2.80		2.50				
		XXS		1.82		1.03					3.40		3.18				
65	2-1/2	5S	95	0.68	44	0.34	0.57	-	190	132	1.20	76	0.98	38	7.11	51	0.23
		10S		0.85		0.48					1.59		1.41				
		40S		1.36		0.77					2.52		2.20				
		80S		1.82		1.00					3.42		3.14				
		160		2.47		1.34					4.60		4.26				
		XXS		3.64		1.99					6.20		6.27				

NOTE: Weights and dimensions listed above are a guide only. Dimensions in mm. Weights in kg.

WOR: Weight on request

* There are 2 possible dimensions for this size, refer to ANSI B16.9

† Length E applies for thickness not exceeding that given in column "Limiting Wall Thickness"

‡ Length E1 applies for thickness greater than that given in column "Limiting Wall Thickness"

Weights and dimensions of larger Butt-weld Fittings are available from your local Prochem office.

BUTTWELD FITTINGS WEIGHTS & DIMENSIONS

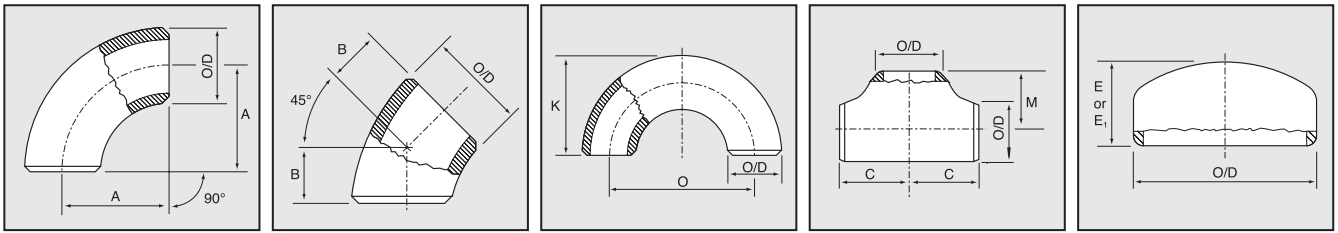

Nominal Size		WT SCH	90° LR ELBOW		45° LR ELBOW		90° SR ELBOW		180° LR ELBOW			Equal Tee		Caps								
mm	inch		A	Weight	B	Weight	A	Weight	O	K	Weight	C and M	Weight	E†	Limiting Wall	E ₁ ‡	Weight					
80	3	5S	114	0.91	51	0.48	76	0.80	229	159	2.00	86	1.55	51	7.62	64	0.39					
		10S		1.22														0.63	0.99	2.40	1.77	0.40
		40S		2.19														1.08	1.50	4.50	3.32	0.71
		80S		2.98														1.50	1.91	5.88	4.45	0.85
		160		4.35														2.18	2.77	8.20	6.50	1.23
		XXS		5.96														3.01	3.82	11.00	8.91	1.70
90	3 - 1/2	5S	133	1.19	57	0.53	89	1.07	267	184	3.20	95	2.50	64	8.13	76	0.55					
		10S		1.70														0.75	1.39	4.00	2.67	0.57
		40S		2.84														1.42	2.06	5.80	4.09	1.02
		80S		4.00														2.00	2.43	7.92	5.45	1.14
		160		-														-	-	-	-	-
		XXS		8.00														4.00	4.86	WOR	10.91	2.27
100	4	5S	152	1.50	64	0.75	102	1.42	305	210	3.68	105	3.27	64	8.64	76	0.57					
		10S		2.16														1.08	1.72	4.44	3.47	0.65
		40S		4.18														2.09	3.13	6.00	5.29	1.22
		80S		6.20														3.10	4.12	12.36	7.73	1.61
		160		9.79														4.94	6.46	19.80	12.21	2.52
		XXS		12.39														6.20	8.24	24.80	15.45	3.22
127	5	5S	190	2.95	79	1.48	127	2.25	381	262	7.60	124	5.91	76	9.65	89	0.91					
		10S		3.64														1.82	2.78	8.52	6.11	1.02
		40S		6.88														3.44	5.29	15.00	9.43	1.85
		80S		9.60														4.80	7.32	18.90	11.36	2.56
		160		16.04														7.96	12.15	30.00	18.98	4.26
		XXS		19.21														9.60	14.64	37.00	22.73	5.12
150	6	5S	229	4.55	95	2.27	152	3.52	457	313	980	143	7.82	89	10.92	102	1.25					
		10S		5.45														2.73	4.16	12.00	8.09	1.36
		40S		10.91														5.45	7.95	18.00	11.02	3.24
		80S		16.36														8.18	11.82	33.60	13.64	4.55
		160		27.16														9.49	19.62	52.00	22.64	7.27
		XXS		32.73														16.36	23.64	60.00	27.27	9.09
200	8	5S	305	7.86	127	3.93	203	7.02	610	414	16.00	178	14.09	102	12.70	127	2.05					
		10S		10.68														5.34	8.01	21.48	15.68	2.50
		40S		21.59														10.80	17.09	40.80	20.95	5.68
		80S		33.18														16.59	24.91	71.40	28.18	7.45
		160		60.00														29.20	45.08	118.00	50.91	13.47
		XXS		57.73														29.03	49.55	122.00	49.09	10.35
250	10	5S	381	14.55	159	7.27	254	12.45	762	518	36.00	216	25.00	127	12.70	152	4.32					
		10S		19.55														9.77	15.91	51.28	26.82	4.91
		40S		38.64														19.32	28.64	79.80	35.45	9.23
		80S		51.82														25.91	45.36	104.00	50.00	12.41
		160		116.36														57.73	101.82	220.00	112.27	27.92
		XXS		-														-	-	-	-	-

NOTE: Weights and dimensions listed above are a guide only. Dimensions in mm. Weights in kg.

WOR: Weight on request

* There are 2 possible dimensions for this size, refer to ANSI B16.9

† Length E applies for thickness not exceeding that given in column "Limiting Wall Thickness"

‡ Length E₁ applies for thickness greater than that given in column "Limiting Wall Thickness"

Weights and dimensions of larger Butt-weld Fittings are available from your local Prochem office.

BUTTWELD FITTINGS WEIGHTS & DIMENSIONS

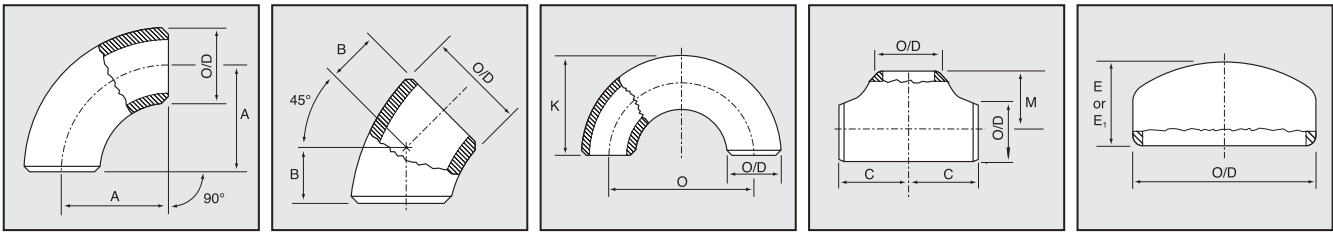

Nominal Size		WT SCH	90° LR ELBOW		45° LR ELBOW		90° SR ELBOW		180° LR ELBOW			Equal Tee		Caps			
mm	inch		A	Weight	B	Weight	A	Weight	O	K	Weight	C and M	Weight	E†	Limiting Wall	E‡	Weight
300	12	5S	457	23.18	190	11.59	305	15.91	914	619	52.00	254	37.73	152	12.70	178	6.36
		10S		27.27		13.64		18.18			59.04		39.55				6.55
		40S		59.55		29.77		36.36			121.00		62.27				13.09
		80S		79.55		39.77		56.82			151.00		84.09				16.64
		160		208.18		104.09		148.64			348.00		220.00				43.18
		XXS		-		-		-			-		-				-
350	14	5S	533	30.91	222	15.45	356	20.00	1067	711	72.00	279	40.45	165	12.70	191	7.73
		10S		36.36		18.18		23.64			81.00		48.64				8.18
		40S		70.45		35.23		45.91			164.00		79.55				16.23
		80S		93.64		46.82		61.36			264.00		95.45				21.82
		160		-		-		-			-		-				-
		XXS		-		-		-			-		-				-
400	16	5S	610	45.45	254	22.73	406	29.55	1219	813	94.00	305	52.27	178	12.70	203	13.64
		10S		47.73		23.86		30.91			105.00		59.09				14.55
		40S		91.82		45.91		59.55			224.00		100.00				22.05
		80S		122.27		60.91		79.55			400.00		120.45				29.55
		160		-		-		-			-		-				-
		XXS		-		-		-			-		-				-
450	18	5S	686	56.82	286	28.41	457	36.82	1372	914	WOR	343	67.73	203	12.70	229	17.27
		10S		60.00		30.00		39.09			WOR		76.82				18.00
		40S		122.27		59.55		79.55			WOR		130.00				27.00
		80S		159.09		79.55		103.64			WOR		156.36				36.00
		160		-		-		-			-		-				-
		XXS		-		-		-			-		-				-
500	20	5S	762	75.00	318	37.50	508	48.64	1524	1016	WOR	381	77.73	229	12.70	254	25.00
		10S		100.00		50.00		65.00			WOR		103.64				27.27
		40S		150.00		75.00		97.73			WOR		162.73				34.09
		80S		199.55		99.55		129.55			WOR		195.45				40.00
		160		-		-		-			-		-				-
		XXS		-		-		-			-		-				-
550	22	5S	838	99.40	343	49.70	559	61.06	1676	1118	WOR	419	84.72	254	12.70	254	WOR
		10S		163.03		81.13		73.02			WOR		101.35				WOR
		40S		163.03		81.13		120.83			WOR		170.07				WOR
		80S		210.83		104.87		156.29			WOR		217.46				WOR
		160		-		-		-			-		-				-
		XXS		-		-		-			-		-				-
600	24	5S	919	127.27	381	63.64	610	82.73	1829	1219	WOR	432	135.45	267	12.70	305	34.09
		10S		140.91		70.45		91.82			WOR		155.91				34.55
		40S		210.91		105.45		137.27			WOR		226.36				44.55
		80S		280.45		140.00		182.27			WOR		272.73				61.36
		160		-		-		-			-		-				-
		XXS		-		-		-			-		-				-

NOTE: Weights and dimensions listed above are a guide only. Dimensions in mm. Weights in kg.

WOR: Weight on request

* There are 2 possible dimensions for this size, refer to ANSI B16.9

† Length E applies for thickness not exceeding that given in column "Limiting Wall Thickness"

‡ Length E1 applies for thickness greater than that given in column "Limiting Wall Thickness"

Weights and dimensions of larger Butt-weld Fittings are available from your local Prochem office.

BUTTWELD FITTINGS WEIGHTS & DIMENSIONS

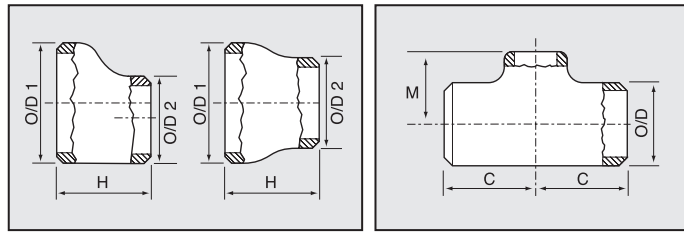

Nominal Size		WT SCH	Concentric and Eccentric Reducers		Reducing Tees		
mm OD1 X OD2	inch OD1 X OD2		H	Weight	C	M	Weight
20 X 15	3/4 X 1/2	5S	38	0.08	29	29	0.09
		10S		0.10			0.11
		40S		0.14			0.15
		80S		0.18			0.18
		160		0.25			0.26
		XXS		0.36			0.37
25 X 15	1 X 1/2	5S	51	0.07	38	38	0.16
		10S		0.12			0.25
		40S		0.15			0.26
		80S		0.20			0.34
		160		0.26			0.47
		XXS		0.40			0.68
25 X 20	1 X 3/4	5S	51	0.08	38	38	0.16
		10S		0.13			0.25
		40S		0.16			0.27
		80S		0.22			0.35
		160		0.28			0.49
		XXS		0.45			0.70
32 X 20	1-1/4 X 3/4	5S	51	0.30	48	48	0.10
		10S		0.44			0.18
		40S		0.52			0.22
		80S		0.60			0.25
		160		0.79			0.33
		XXS		1.20			0.51
32 X 25	1-1/4 X 1	5S	51	0.10	48	48	0.31
		10S		0.18			0.45
		40S		0.22			0.53
		80S		0.27			0.61
		160		0.37			0.80
		XXS		0.54			1.23
40 X 20	1-1/2 X 3/4	5S	64	0.11	57	57	0.37
		10S		0.18			0.59
		40S		0.24			0.74
		80S		0.32			0.88
		160		0.45			1.23
		XXS		0.65			1.76

Nominal Size		WT SCH	Concentric and Eccentric Reducers		Reducing Tees		
mm OD1 X OD2	inch OD1 X OD2		H	Weight	C	M	Weight
40 X 25	1-1/2 X 1	5S	64	0.11	57	57	0.38
		10S		0.20			0.60
		40S		0.26			0.76
		80S		0.34			0.90
		160		0.47			1.26
		XXS		0.67			1.80
40 X 32	1-1/2 X 1-1/4	5S	64	0.12	57	57	0.39
		10S		0.21			0.61
		40S		0.28			0.78
		80S		0.36			0.92
		160		0.51			1.29
		XXS		0.73			1.84
50 X 20	2 X 3/4	5S	76	0.15	64	44	0.46
		10S		0.25			0.72
		40S		0.36			1.09
		80S		0.50			1.35
		160		0.79			2.12
		XXS		1.01			2.70
50 X 25	2 X 1	5S	76	0.17	64	51	0.47
		10S		0.28			0.73
		40S		0.40			1.10
		80S		0.54			1.37
		160		0.84			2.15
		XXS		1.07			2.74
50 X 40	2 X 1-1/2	5S	76	0.19	64	60	0.49
		10S		0.31			0.76
		40S		0.45			1.15
		80S		0.59			1.43
		160		0.93			2.25
		XXS		1.18			2.86
65 X 25	2-1/2 X 1	5S	89	0.25	76	57	0.83
		10S		0.38			1.20
		40S		0.65			1.87
		80S		0.87			2.66
		160		1.18			3.62
		XXS		1.75			5.33

NOTE: Weights and dimensions listed above are a guide only. Dimensions in mm. Weights in kg.

WOR: Weight on request

* There are 2 possible dimensions for this size, refer to ANSI B16.9

Weights and dimensions of larger Buttweld Fittings are available from your local Prochem office.

BUTTWELD FITTINGS WEIGHTS & DIMENSIONS

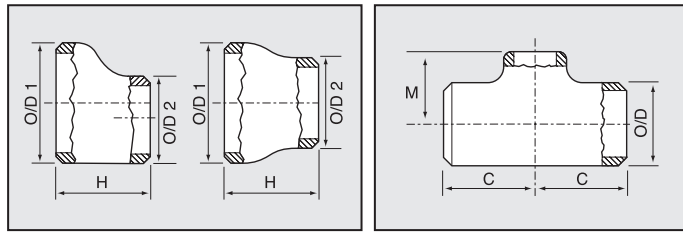

Nominal Size		WT SCH	Concentric and Eccentric Reducers		Reducing Tees		
mm OD1 X OD2	inch OD1 X OD2		H	Weight	C	M	Weight
65 X 40	2-1/2 X 1-1/2	5S	89	0.30	76	67	0.86
		10S		0.45			1.24
		40S		0.76			1.94
		80S		0.94			2.76
		160		1.27			3.75
		XXS		1.88			5.52
64 X 50	2-1/2 X 2	5S	89	0.32	76	70	0.88
		10S		0.47			1.27
		40S		0.80			1.98
		80S		1.03			2.82
		160		1.39			3.84
		XXS		2.05			5.65
80 X 40	3 X 1-1/2	5S	89	0.35	86	73	1.33
		10S		0.51			1.52
		40S		0.94			2.85
		80S		1.21			3.83
		160		1.75			5.59
		XXS		2.42			7.66
80 X 50	3 X 2	5S	89	0.38	86	76	1.36
		10S		0.55			1.56
		40S		1.00			2.92
		80S		1.30			3.92
		160		1.88			5.72
		XXS		2.59			7.84
80 X 65	3 X 2-1/2	5S	89	0.41	86	83	1.39
		10S		0.59			1.60
		40S		1.08			2.99
		80S		1.49			4.01
		160		2.16			5.85
		XXS		2.98			8.02
100 X 65	4 X 1-1/2	5S	102	0.48	105	86	2.75
		10S		0.68			2.91
		40S		1.36			4.44
		80S		1.90			6.49
		160		2.98			10.25
		XXS		3.80			12.98

Nominal Size		WT SCH	Concentric and Eccentric Reducers		Reducing Tees		
mm OD1 X OD2	inch OD1 X OD2		H	Weight	C	M	Weight
100 X 50	4 X 2	5S	102	0.55	105	89	2.78
		10S		0.79			2.95
		40S		1.58			4.49
		80S		1.96			6.57
		160		3.07			10.38
		XXS		3.92			13.14
100 X 65	4 X 2-1/2	5S	102	0.58	105	95	2.81
		10S		0.83			2.98
		40S		1.66			4.55
		80S		2.20			6.65
		160		3.45			10.50
		XXS		4.39			13.29
100 X 80	4 X 3	5S	102	0.61	105	98	2.88
		10S		0.87			3.05
		40S		1.75			4.65
		80S		2.34			6.80
		160		3.67			10.74
		XXS		4.67			13.60
125 X 080	5 X 3	5S	127	1.20	124	111	5.08
		10S		1.45			5.25
		40S		2.86			8.11
		80S		3.89			9.77
		160		6.45			16.32
		XXS		7.77			19.55
125 X 100	5 X 4	5S	127	1.25	124	117	5.32
		10S		1.50			5.50
		40S		2.99			8.49
		80S		4.14			10.23
		160		6.87			17.08
		XXS		8.28			20.45
150 X 80	6 X 3	5S	140	1.51	143	124	6.65
		10S		1.82			6.88
		40S		3.99			11.96
		80S		5.52			11.59
		160		9.17			19.24
		XXS		11.05			23.18

NOTE: Weights and dimensions listed above are a guide only. Dimensions in mm. Weights in kg.

WOR: Weight on request

* There are 2 possible dimensions for this size, refer to ANSI B16.9

Weights and dimensions of larger Butt weld Fittings are available from your local Prochem office.

BUTTWELD FITTINGS WEIGHTS & DIMENSIONS

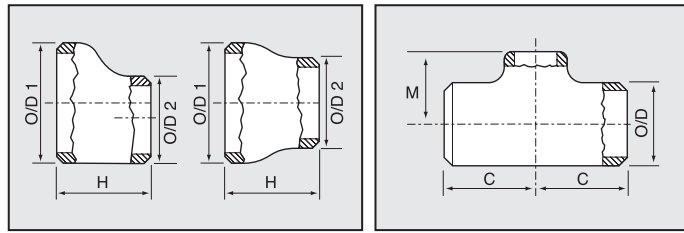

Nominal Size		WT SCH	Concentric and Eccentric Reducers		Reducing Tees		
mm OD1 X OD2	inch OD1 X OD2		H	Weight	C	M	Weight
150 X 100	6 X 4	5S	140	1.55	143	130	6.88
		10S		1.96			7.12
		40S		4.09			9.70
		80S		5.97			12.00
		160		9.91			19.92
		XXS		11.95			24.00
150 X 125	6 X 5	5S	140	1.64	143	137	7.04
		10S		2.02			7.28
		40S		4.31			9.92
		80S		6.27			12.27
		160		10.40			20.37
		XXS		12.54			24.55
200 X 100	8 X 4	5S	152	2.16	178	156	12.12
		10S		3.02			13.49
		40S		6.56			18.02
		80S		9.25			24.24
		160		16.75			43.77
		XXS		16.20			42.23
200 X 125	8 X 5	5S	152	2.21	178	162	12.40
		10S		3.09			13.80
		40S		6.72			18.44
		80S		9.69			24.80
		160		17.50			44.77
		XXS		16.96			43.18
200 X 150	8 X 6	5S	152	2.30	178	168	12.68
		10S		3.20			14.11
		40S		6.96			18.86
		80S		10.15			25.36
		160		18.32			45.91
		XXS		17.75			44.18
250 X 100	10 X 4	5S	178	3.79	216	184	21.25
		10S		4.74			23.25
		40S		10.54			30.14
		80S		12.58			42.50
		160		28.32			95.45
		XXS		-			-

Nominal Size		WT SCH	Concentric and Eccentric Reducers		Reducing Tees		
mm OD1 X OD2	inch OD1 X OD2		H	Weight	C	M	Weight
250 X 125	10 X 5	5S	178	3.92	216	191	21.50
		10S		4.90			23.06
		40S		10.89			30.49
		80S		14.27			43.00
		160		32.09			96.36
		XXS		-			-
250 X 150	10 X 6	5S	178	4.01	216	194	22.00
		10S		5.01			23.60
		40S		11.15			31.20
		80S		14.82			44.00
		160		33.32			98.64
		XXS		-			-
250 x 200	10 x 8	5S	178	4.17	216	194	22.50
		10S		5.21			24.14
		40S		11.58			31.91
		80S		15.61			45.00
		160		35.05			100.91
		XXS		-			-
300 X 150	12 X 6	5S	203	6.37	254	219	32.45
		10S		7.45			34.01
		40S		15.51			53.64
		80S		20.19			72.27
		160		52.73			189.09
		XXS		-			-
300 X 200	12 X 8	5S	203	6.57	254	229	33.20
		10S		7.69			34.80
		40S		16.02			54.55
		80S		20.94			74.09
		160		54.55			193.64
		XXS		-			-
300 X 250	12 X 10	5S	203	6.83	254	241	33.95
		10S		8.00			35.59
		40S		16.67			55.91
		80S		21.68			75.45
		160		56.36			197.73
		XXS		-			-

NOTE: Weights and dimensions listed above are a guide only. Dimensions in mm. Weights in kg.

WOR: Weight on request

* There are 2 possible dimensions for this size, refer to ANSI B16.9

Weights and dimensions of larger Buttweld Fittings are available from your local Prochem office.

BUTTWELD FITTINGS WEIGHTS & DIMENSIONS

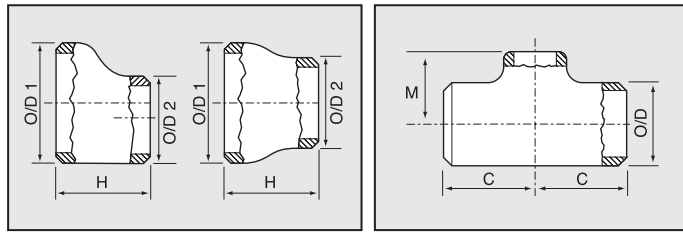

Nominal Size		WT SCH	Concentric and Eccentric Reducers		Reducing Tees		
mm OD1 X OD2	inch OD1 X OD2		H	Weight	C	M	Weight
350 X 150	14 X 6	5S	330	10.81	279	238	34.39
		10S		13.18			41.34
		40S		26.36			67.27
		80S		35.37			80.91
		160		-			-
		XXS		-			-
350 X 200	14 X 8	5S	330	11.41	279	248	34.79
		10S		13.91			41.83
		40S		27.83			68.18
		80S		36.92			81.82
		160		-			-
		XXS		-			-
350 X 250	14 X 10	5S	330	11.84	279	257	35.60
		10S		14.44			42.80
		40S		28.89			70.00
		80S		38.82			84.09
		160		-			-
		XXS		-			-
350 X 300	14 X 12	5S	330	12.56	279	270	36.41
		10S		15.32			43.77
		40S		30.65			71.36
		80S		40.44			85.91
		160		-			-
		XXS		-			-
400 X 200	16 X 8	5S	356	14.72	305	273	44.43
		10S		16.73			50.00
		40S		33.46			85.00
		80S		44.31			102.27
		160		-			-
		XXS		-			-
400 X 250	16 X 10	5S	356	15.62	305	283	44.95
		10S		17.75			50.91
		40S		35.51			85.91
		80S		46.36			103.64
		160		-			-
		XXS		-			-

Nominal Size		WT SCH	Concentric and Eccentric Reducers		Reducing Tees		
mm OD1 X OD2	inch OD1 X OD2		H	Weight	C	M	Weight
400 X 300	16 X 12	5S	356	16.18	305	295	45.91
		10S		18.39			51.82
		40S		36.78			87.73
		80S		47.73			105.91
		160		-			-
		XXS		-			-
400 X 350	16 X 14	5S	356	16.58	305	305	46.82
		10S		18.85			53.18
		40S		37.69			90.00
		80S		49.09			108.18
		160		-			-
		XXS		-			-
450 X 250	18 X 10	5S	381	18.54	343	308	57.27
		10S		21.06			65.00
		40S		42.13			110.45
		80S		54.55			132.73
		160		-			-
		XXS		-			-
450 X 300	18 X 12	5S	381	18.94	343	321	58.18
		10S		21.52			65.91
		40S		43.05			111.82
		80S		57.27			134.55
		160		-			-
		XXS		-			-
450 X 350	18 X 14	5S	381	19.31	343	330	59.55
		10S		21.95			67.27
		40S		43.89			114.09
		80S		57.73			137.73
		160		-			-
		XXS		-			-
450 X 400	18 X 16	5S	381	19.84	343	330	60.91
		10S		22.55			69.09
		40S		45.09			116.82
		80S		59.09			140.45
		160		-			-
		XXS		-			-

NOTE: Weights and dimensions listed above are a guide only. Dimensions in mm. Weights in kg.

WOR: Weight on request

* There are 2 possible dimensions for this size, refer to ANSI B16.9

Weights and dimensions of larger Butt Weld Fittings are available from your local Prochem office.

BUTTWELD FITTINGS WEIGHTS & DIMENSIONS

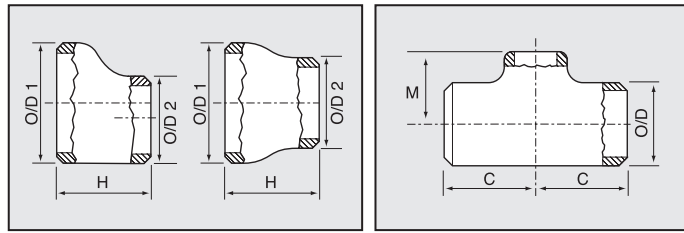

Nominal Size		WT SCH	Concentric and Eccentric Reducers		Reducing Tees		
mm OD1 X OD2	inch OD1 X OD2		H	Weight	C	M	Weight
500 X 300	20 X 12	5S	508	32.50	381	346	65.91
		10S		32.50			87.73
		40S		65.00			138.18
		80S		85.91			165.91
		160		-			-
		XXS		-			-
500 X 350	20 X 14	5S	508	32.95	381	356	66.82
		10S		38.23			89.09
		40S		65.91			140.00
		80S		87.27			168.18
		160		-			-
		XXS		-			-
500 X 400	20 X 16	5S	508	33.18	381	356	68.18
		10S		38.49			90.91
		40S		66.36			143.18
		80S		88.64			171.82
		160		-			-
		XXS		-			-
500 X 450	20 X 18	5S	508	34.32	381	368	70.00
		10S		26.17			93.18
		40S		68.64			146.36
		80S		90.00			175.91
		160		-			-
		XXS		-			-
550 X 350	22 X 14	5S	508	WOR	419	381	WOR
		10S		36.01			WOR
		40S		59.08			WOR
		80S		76.97			WOR
		160		-			-
		XXS		-			-
550 X 400	22 X 16	5S	508	WOR	419	381	78.00
		10S		38.01			130.23
		40S		62.40			130.23
		80S		81.25			169.22
		160		-			-
		XXS		-			-

Nominal Size		WT SCH	Concentric and Eccentric Reducers		Reducing Tees		
mm OD1 X OD2	inch OD1 X OD2		H	Weight	C	M	Weight
550 X 450	22 X 18	5S	508	WOR	419	394	78.47
		10S		WOR			131.14
		40S		WOR			131.14
		80S		WOR			170.74
		160		-			-
		XXS		-			-
550 X 500	22 X 20	5S	508	WOR	419	406	78.94
		10S		42.01			132.06
		40S		68.94			132.06
		80S		89.80			172.88
		160		-			-
		XXS		-			-
600 X 400	24 X 16	5S	508	44.55	432	406	116.36
		10S		44.55			134.09
		40S		76.82			194.55
		80S		102.73			234.55
		160		-			-
		XXS		-			-
600 X 450	24 X 18	5S	508	45.45	432	419	119.09
		10S		45.45			137.27
		40S		78.64			199.09
		80S		104.55			240.00
		160		-			-
		XXS		-			-
600 X 500	24 X 20	5S	508	46.82	432	432	121.82
		10S		46.82			140.00
		40S		81.36			203.64
		80S		106.36			245.45
		160		-			-
		XXS		-			-
600 X 550	24 X 22	5S	508	WOR	432	432	98.59
		10S		52.91			141.16
		40S		75.53			141.16
		80S		98.36			184.53
		160		-			-
		XXS		-			-

NOTE: Weights and dimensions listed above are a guide only. Dimensions in mm. Weights in kg.

WOR: Weight on request

* There are 2 possible dimensions for this size, refer to ANSI B16.9

Weights and dimensions of larger Buttweld Fittings are available from your local Prochem office.